

RIDE
AMERICA[®]
BRAKE & CLUTCH SYSTEM

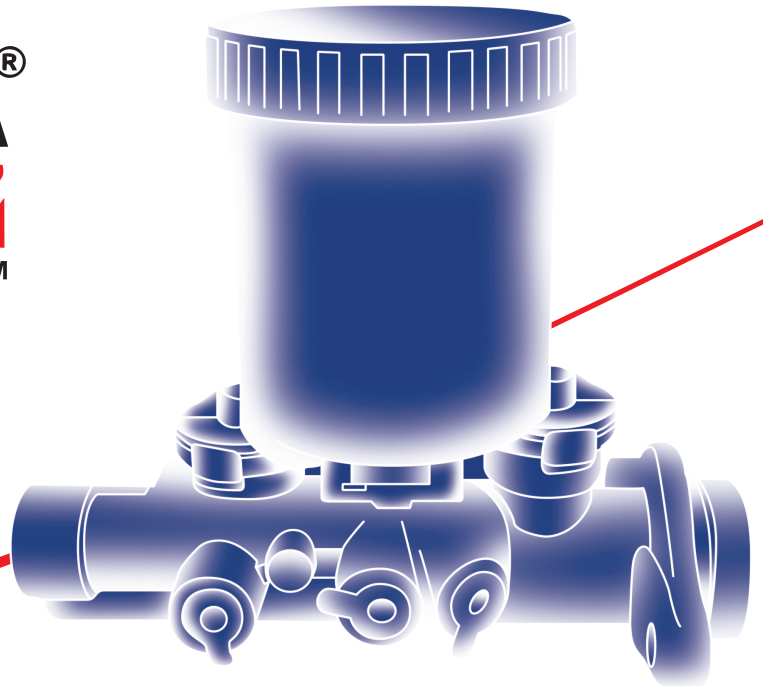

CILINDROS DE FRENOS 2015



RIDE AMERICA®

BRAKE & CLUTCH SYSTEM

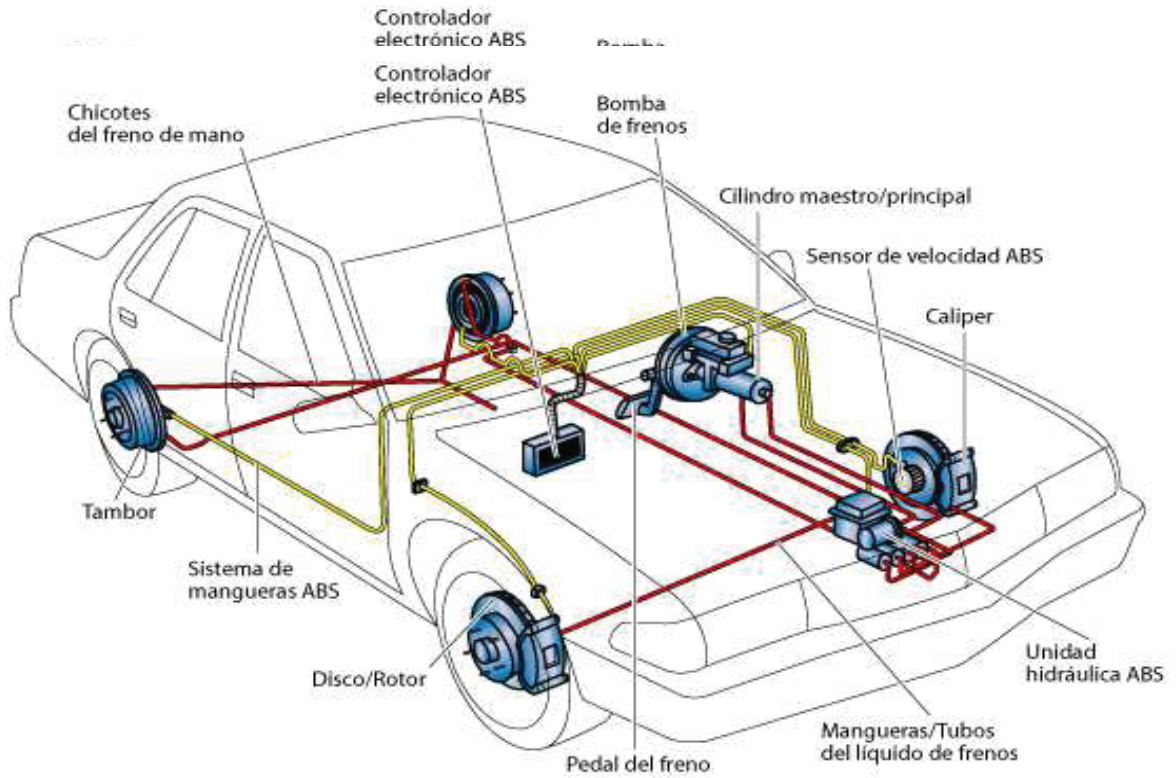

RAMF-098895

LUSAC	RAYBESTOS	AUTOPAR	WAGNER	RUVILLE	OEM
LC-98895	MC39178	FCM05004	F98895	BMC10453	4294884

CHRYSLER



28.5mm 1-1/8"

Cil.Mtro Freno Dodge B150 Van 89-81; B250 Van 89-81; B350 Van 89-81; D100 Pickup 89-86; D150 Pickup 93-81; D250 Pickup 88-81; D350 Pickup 85-81; D400 Pickup 81; D450 Pickup 81; Ramcharger 93-81; W100 Pickup 89-86; W150 Pickup 93-81

RAMF-108134

LUSAC	RAYBESTOS	AUTOPAR	WAGNER	RUVILLE	OEM
LC-108134	MC39451	FCM05006	F108134	BMC10465	4509602

CHRYSLER



21.00mm

Chrysler Dart K 83-88, Dart K Guayin 83-88, Dart E 89, Le Baron K 83-87, Magnum K 83-88, New Yorker 85-99, Phantom 87-89, Serie 600 K 84-85, Shadow 89-94, Shadow GTS 90-91, Shadow Turbo 92-94, Volare K 83-88 Cil.Mtro Freno Chrysler E Class 84-83; Executive Sedan 84-83; Laser 86-84; Lebaron 88-83; New Yorker 88-83; Town & Country 88-83; Dodge 400 83; 600 88-83; Aries 89-

RAMF-108168

LUSAC	RAYBESTOS	AUTOPAR	WAGNER	RUVILLE	OEM
LC-108168	MC39476	FCM05007	F108168	BMC10467	FMC-39498

CHRYSLER

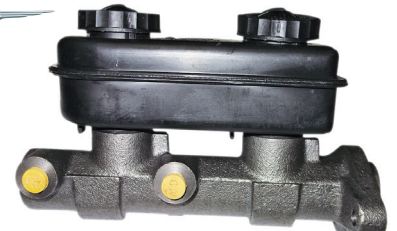

24.0mm

CHRYSLER IMPERIAL, LE BARON, NEW YORK, PHANTOM, SPIRIT RT, VOYAGER, GRAND, VOYAGER, TOWN & COUNTRY

RAMF-390251

LUSAC	RAYBESTOS	AUTOPAR	WAGNER	RUVILLE	OEM
LC-390251	MC390251	FCM05015	F131327	BMC10154	4764192

CHRYSLER



22.2mm 7/8"

Chrysler Breeze Rin 14" 96, Cirrus 96-00, Sebring RT 97, Stratus 95-02 sin ABS

RAMF-390257

LUSAC	RAYBESTOS	AUTOPAR	WAGNER	RUVILLE	OEM
390257	MC390257	FCM05009	F131472	BMC10156	4778453

CHRYSLER



31.7mm 1-1/4"

Chrysler Ram 1500 4X2, 4X4 97, Ram 2500 y Club Cab Larami 4X2, 4X4 (7,500 Lb) 95-97, Chevrolet C-15 95-99 C-20, C-25 y Cheyenne 95-01 Cil.Mtro Freno Chrys Ram 1500 2x2, 4x4 97, Ram 2500 2x2, 4x4 (7,500 Lb) 95-97 Chevrolet C-15 95, C-20, C-25 95-00, Silverado 1500, 2500 Con Hidrobooster 95-99 Suburban 88-00

RAMF-390257

LUSAC	RAYBESTOS	AUTOPAR	WAGNER	RUVILLE	OEM
LC-390257	MC390257	FCM05009	F131472	BMC10156	4778453

CHRYSLER



31.7mm 1-1/4"

GMC TRUCK, DODGE TRUCK RAM 1500 PICK-UP -1/2 TON, RAM 2500 PICKUP -3/4 TON, GMC TRUCK YUKON

RAMF-390275

LUSAC	RAYBESTOS	AUTOPAR	WAGNER	RUVILLE	OEM
LC-390275	MC390275	FCM05014	F131512	BMC10162	4683264

CHRYSLER

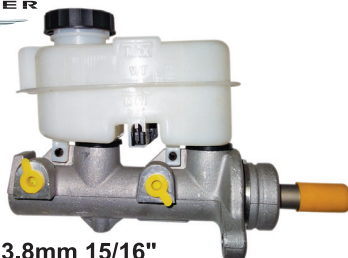

23.8mm 15/16"

CHRYSLER GRAND VOYAGER RIN 15" Y 16" CON ABS SIN CONTROL DE TRACC. TOWN COUNTRY RIN 14"96; VOYAGER RIN 14" SIN CONTROL DE TRACCION

RAMF-390377

LUSAC	RAYBESTOS	AUTOPAR	WAGNER	RUVILLE	OEM
390377	MC390377	FCM05019	F131963	BMC10183	4721321

CHRYSLER



23.8mm 15/16"

Chrysler Grand Voyager Rin 15" y 16" 97-00, Town & Country Rin 14" con Control de Tracc. 96-00, Voyager con Control Tracc. 97-00, Ram 4000 05-06

RAMF-390426

LUSAC	RAYBESTOS	AUTOPAR	WAGNER	RUVILLE	OEM
LC-390426	MC390426	FCM05021	F134430	BMC10196	5011256AB

CHRYSLER



31.7mm 1-1/4"

Chrysler Ram Charger 99-01, Ram Runner V-10 97, Ram 1500 97-01, Ram 2500 y Club Cab Larami 97-01, Ram 3500 98-02, Ram 4000 98-01

RAMF-390516

LUSAC	RAYBESTOS	AUTOPAR	WAGNER	RUVILLE	OEM
390516	MC390516		F141078	BMC10207	4897210AA 4897210AB



31.7mm 1-1/4"

Chrysler Ram Van y Ram Wagon 1500 96-03, Ram Van y Ram Wagon 2500, 96-02, Ram Van y Ram Wagon 3500 98-02, Gran Voyager sin Control de Tracc. 97-00. Town & Country sin Control de Tracc. 97-00

RAMF-39178

LUSAC	RAYBESTOS	AUTOPAR	WAGNER	RUVILLE	OEM
LC-98895	MC39178	FCM05004	F98895	BMC10453	4294884

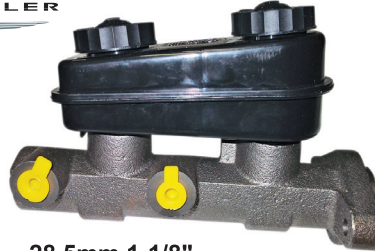

28.5mm 1-1/8"

DODGE D150, MICROBUS

RAMF-75818

LUSAC	RAYBESTOS	AUTOPAR	WAGNER	RUVILLE	OEM
LC-75818	MC36307				

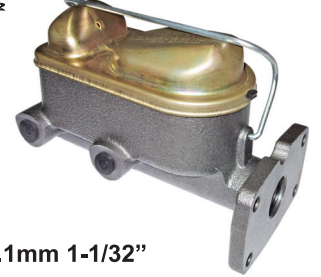

26.1mm 1-1/32"

Chrysler Super Bee 71-75. Monaco 71-73. D-100 72-73

RAMF-80568

LUSAC	RAYBESTOS	AUTOPAR	WAGNER	RUVILLE	OEM
LC-80568	MC36461				

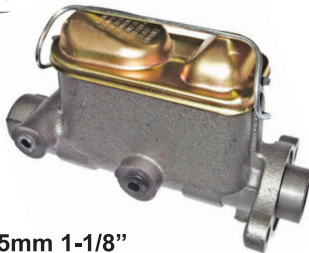

28.5mm 1-1/8"

Chrysler Dodge D-300 72-78, M-300 78

RAMF-99294

LUSAC	RAYBESTOS	AUTOPAR	WAGNER	RUVILLE	OEM
LC-99294	MC39034	FCM05005	F99294	BMC10176	3766275 3776254 3880289 4205972

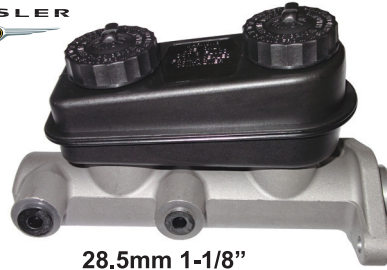

28.5mm 1-1/8"

Chrysler Cordoba 80-82, Dart 79-82, Le Baron 79-82, Magnum 81-82, Valiant Volare 78-81, Super Bee 80

RAMF-102421

LUSAC	RAYBESTOS	AUTOPAR	WAGNER	RUVILLE	OEM
LC-102421	MC39173	FCM08013	F102421	BMC10452	E0T22140B



26.9mm 1-1/16"

Ford F-350 80-83

RAMF-110919

LUSAC	RAYBESTOS	AUTOPAR	WAGNER	RUVILLE	OEM
110919	MC39445	FCM08017	F110919	BMC10464	E4T22140B



28.5mm 1-1/8"

Cil. Mtro Freno Ford E-250 Econoline 86-84; E-350 Econoline 86-84; F-250 Pickup 86-84; F-350 Pickup 86-84

RAMF-114075

LUSAC	RAYBESTOS	AUTOPAR	WAGNER	RUVILLE	OEM
114075	MC39628	FCM08021	F114075	BMC10477	E79Z2140A



23.8mm 15/16"

Ford Camioneta Aerostar 87-89 USA

RAMF-114079

LUSAC	RAYBESTOS	AUTOPAR	WAGNER	RUVILLE	OEM



28.5mm 1-1/8"

FORD F-150, F-250

RAMF-117583

LUSAC	RAYBESTOS	AUTOPAR	WAGNER	RUVILLE	OEM
117583	MC39637	FCM08023	F117583	BMC10481	E9ZZ2140A



21.0 & 30.2mm

Ford Cougar 87-88, Mustang 83-84, Thunderbird 87-88

RAMF-120369

LUSAC	RAYBESTOS	AUTOPAR	WAGNER	RUVILLE	OEM
LC-120369	MC39634	FCM08024	F120369	BMC10478	F4TZ2140E



26.1mm 1-1/32"

Ford F-150 S/C/de Velocidad 87-04, F-200 87-91, F-250 92, Econoline Van E 150 95-96, Club Wagon V6 E 150 95-96, Lobo 97-99 Ford Bronco 96-87; E-150 Econoline 96-88; E-250 Econoline 91-87; F-150 Pickup 96-87; F-250 Pickup 92-87

RAMF-122576

LUSAC	RAYBESTOS	AUTOPAR	WAGNER	RUVILLE	OEM
LC-39953	MC39953	FCM08003	F122576	BMC10190	F0T2Z140A



28.5mm 1-1/8"

Cil. Mtro Freno Ford Explorer 94-91; Ranger 94-90; Mazda B2300 94; B3000 94; B4000 94; Navajo 94-91

RAMF-131399

LUSAC	RAYBESTOS	AUTOPAR	WAGNER	RUVILLE	OEM
390269	MC390269	FCM08031	F131399	BMC10160	F67Z2140HA



26.9mm 1-1/16"

Ford Explorer XLS V6, XLT V8, Limited 95-97 sin Control de Velocidad, Ranger Tambor de 9" 96-97 RANGER 2.3 3.0 EXPLORER 95-97, MAZDA B2300, B3000

RAMF-390184

LUSAC	RAYBESTOS	AUTOPAR	WAGNER	RUVILLE	OEM
390184	MC390184	FCM08064			



28.5mm 1-1/8"

Ford F-250 95, F-350 94, P-350 94-96 C/ Control de Vel Doble Rodada

RAMF-390268

LUSAC	RAYBESTOS	AUTOPAR	WAGNER	RUVILLE	OEM
LC-390269	MC390269	FCM08031	F131399	BMC10160	F67Z2140HA



26.9mm 1-1/16"

FORD EXPLORER XLS V6 XLT V8 LIMITED SIN CONTROL DE VELOCIDAD, RANG TAMBOR DE 9"

RAMF-390337

LUSAC	RAYBESTOS	AUTOPAR	WAGNER	RUVILLE	OEM
LC-390337	MC390337	FCM08034	F131993	BMC10173	F6T2Z140BA



31.7mm 1-1/4"

LINCOLN NAVIGATOR D/D, EXPEDITION XLT EDDLE BAUER, F-150, F-250, F-250 SUPER DUTY, F-350, F-350 XL V8 TRITON RODADA DOBLE, F-350 SUPER DUTY, F-250 LOBO, P-350

RAMF-390339

LUSAC	RAYBESTOS	AUTOPAR	WAGNER	RUVILLE	OEM
LC-390339	MC390339	FCM08054	F131972	BMC10175	F6T2Z140AB



31.7mm 1-1/4"

FORD F-250, F-250 SUPER DUTY V8, F-350 (RODADA SENCILLA), LOBO, P-350 (DISCO TAMBOR SIN C/VEL).

RAMF-390399

LUSAC	RAYBESTOS	AUTOPAR	WAGNER	RUVILLE	OEM
LC-390399	MC390399		F139953	BMC10190	F87Z2140AC



26.9mm 1-1/16"

FORD TRUCK EXPLORER, EXPLORER SPORT, RANGER, SPORT TRAC, MAZDA TRUCK B-2300, B-3000, B-4000, MERCURY TRUCK MOUNTAINEER

RAMF-390400

LUSAC	RAYBESTOS	AUTOPAR	WAGNER	RUVILLE	OEM
LC-390400	MC390400		F139954	BMC10191	F87Z2140BA



26.9mm 1-1/16"

EXPLORER XLS V6, XLT V8, LIMITED, EXPLORER SPORT, RANGER CON CAJA DE VELOCIDAD

RAMF-80903

LUSAC	RAYBESTOS	AUTOPAR	WAGNER	RUVILLE	OEM
LC-80903	MC36397	FCM08006			4764192



25.4mm 1"

Ford Galaxie 73-74, LTD Crown Victoria 75-78

RAMF-83575

LUSAC	RAYBESTOS	AUTOPAR	WAGNER	RUVILLE	OEM
LC-83575	MC36399	FCM08007			



25.4mm 1"

F-100 71-79, F-100 USA 73-79

RAMF-86130

LUSAC	RAYBESTOS	AUTOPAR	WAGNER	RUVILLE	OEM
86130	MC36445	FCM08008			



RAMF-97934

LUSAC	RAYBESTOS	AUTOPAR	WAGNER	RUVILLE	OEM
LC-97934	MC39011	FCM08009	F97934	BMC10136	D7TZ2140C D7TZ2140C



25.4mm 1"

Ford F-150 80-86, P-350 77-78, BRONCO 78-86, E-150 ECONOLINE 77-86

RAMF-97938

LUSAC	RAYBESTOS	AUTOPAR	WAGNER	RUVILLE	OEM
LC-97938	MC39116	FCM08011			

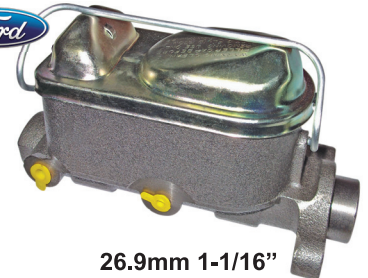

26.9mm 1-1/16"

Ford F-350 77-79, P-350 77-78

RAMF-99084

LUSAC	RAYBESTOS	AUTOPAR	WAGNER	RUVILLE	OEM
LC-99084	MC39037	FCM08012	F99084	BMC10180	D9BZ2140A D9BZ2140A



22.2mm 7/8"

Ford Fairmont, Fairmont Vagoneta 78-81, Mustang 79-81 con Booster

RAMF-039646

LUSAC	RAYBESTOS	AUTOPAR	WAGNER	RUVILLE	OEM
LC-39646	MC39646	FCM09001	F116881	BMC10482	18060086



28.5mm 1-1/8"

Chrysler Ram 1500 94, Ram 2500 91-94, Ram Club Cab 91-93, Chevrolet Blazer Nevada 92-94, Suburban 88-94, C15 94, C-20, 25 88-91, C-20, C-25 y Cheyene 92-94

RAMF-101253

LUSAC	RAYBESTOS	AUTOPAR	WAGNER	RUVILLE	OEM
LC-101253	MC39016	FCM09006	F101253	BMC10140	18003755 FMC-39017



23.8mm 15/16"

BUICK, CHEVROLET, OLDSMOBILE, PONTIAC, CHEVROLET/GMC TRUCK

RAMF-101254

LUSAC	RAYBESTOS	AUTOPAR	WAGNER	RUVILLE	OEM
LC-101254	MC36306	FCM09007	F101254	BMC10130	18002063

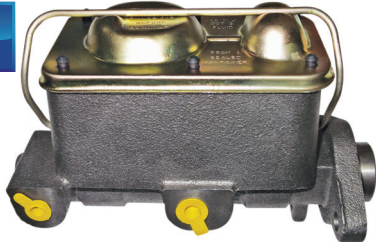

28.5mm 1-1/8"

Dina 1000 75-76 y 80-81 con Boster Chevrolet Caprice 78-80, Chevelle 71-75, Chevelle Malibu 70-75, Chevy Nova 75-78, Impala 71-75, C10 72-78, VAM con Boster Wagoneer 77-80 Wagoneer J-164 74-76

RAMF-101266

LUSAC	RAYBESTOS	AUTOPAR	WAGNER	RUVILLE	OEM
LC-101266	MC39075	FCM09009	F101266	BMC10257	18008633

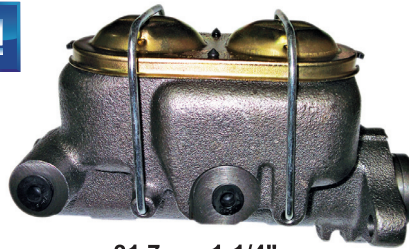

31.7mm 1-1/4"

DINA 3000, 3200, CHEVROLET C30, C35

RAMF-104460

LUSAC	RAYBESTOS	AUTOPAR	WAGNER	RUVILLE	OEM
104460	MC39328	FCM09011	F104460	BMC10456	18013426



28.6 & 40mm

Buik Autos Americanos: Elektra 81-84, Le Sabre 81-89 Cadillac Autos Americanos: DeVille 81-84, FLEETWOOD 87-92, Chevrolet Caprice 81-82

RAMF-104464

LUSAC	RAYBESTOS	AUTOPAR	WAGNER	RUVILLE	OEM
LC-104464	MC39324	FCM09012	F104464	BMC10455	18008068



31.7mm 1-1/4"

Chevrolet Camionetas C, K, R 20 Americana, Suburban C-30 81-89 Americana

RAMF-104466

LUSAC	RAYBESTOS	AUTOPAR	WAGNER	RUVILLE	OEM
LC-104466	MC39589	FCM09032	F104466	BMC10475	18007971



25.4 & 36.0mm

Cil. Mtro Freno Chevrolet C10 Pickup 86-81; R10 Pickup 87; GMC C15/C1500 Pickup 86-81; R1500 Pickup 87

RAMF-104516

LUSAC	RAYBESTOS	AUTOPAR	WAGNER	RUVILLE	OEM
LC-104516	MC39223	FCM09013	F104516	BMC10454	18013435



28.5 & 40.0mm

Chevrolet Blazer Nevada 91 4X4 y 4X2, C15 82-87, C20, C25 79-87, Suburban 87, Dina Camionetas 1000 81-83, 3000, 3200 80-83, VAM Willy Camioneta 79-89, Wagoneer 81-86

RAMF-107050

LUSAC	RAYBESTOS	AUTOPAR	WAGNER	RUVILLE	OEM
LC-107050	MC39376	FCM09014	F107050		18013429



24.0mm

Chevrolet Montecarlo 82-84, Cutlass Supreme 87-88 USA

RAMF-107747

LUSAC	RAYBESTOS	AUTOPAR	WAGNER	RUVILLE	OEM
39571	MC39571	FCM09004	F107747	BMC10472	18013433



24.0 & 36.0mm

Cil.Mtro Freno Chevrolet Blazer 97-95; S10 Blazer 94-83; S10 Pickup 98-83; GMC Jimmy 97-95; S15 Jimmy 94-83; S15 Pickup 90-83; Sonoma 97-91; Syclone 91; Typhoon 93-92; Oldsmobile Bravada 97-91

RAMF-110887

LUSAC	RAYBESTOS	AUTOPAR	WAGNER	RUVILLE	OEM
LC-110887	MC39578	FCM09018	F110887		18013440



28.5mm 1-1/8"

CHEVROLET CAMIONETA G-10, G-20, P-25 (MOD USA)

RAMF-116403

LUSAC	RAYBESTOS	AUTOPAR	WAGNER	RUVILLE	OEM
116403	MC39382	FCM09021	F116403	BMC10460	18010087



22.2mm 7/8"

Chevrolet Century 83-86, Celebrity 83-84, Citation 83-85

RAMF-131468

LUSAC	RAYBESTOS	AUTOPAR	WAGNER	RUVILLE	OEM
LC-39646	MC39646		F131468 F116881		



Cil. Mtro Freno Cadillac Escalade 00; Chev C1500 Pickup 99-95; C1500 Suburban 99-95; C2500 Pickup 98-94; C2500 Suburban 98-94; K1500 Pickup 99-94; K1500 Suburban 99-94;

RAMF-390174

LUSAC	RAYBESTOS	AUTOPAR	WAGNER	RUVILLE	OEM
390174	MC390174	FCM09022	F122617	BMC10143	18021213

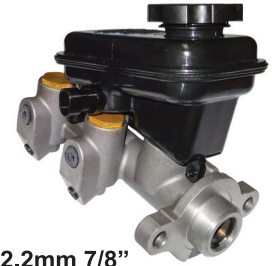

22.2mm 7/8"

Chevrolet Cavalier 92-94, Cavalier Z24 92-94

RAMF-390259

LUSAC	RAYBESTOS	AUTOPAR	WAGNER	RUVILLE	OEM
390259	MC390259	FCM09024	F131468	BMC10158	18021273



28.5mm 1-1/8"

Chevrolet Silverado 95-99, C-15 95-99, C-20 C-25 y Cheyenne 95-01, Sonora 00-02, Suburban 95-00, Chrysler Ram Runner V-10 96, Ram 1500 95-96, Ram 2500 y Club Cab 95-96 Cadillac Escalade 00; Chev C1500 Pickup 99-95; C1500 Suburban 99-95; C2500 Pickup 98-94; C2500 Suburban 98-94; K1500 Pickup 99-94; K1500 Suburban 99-94; K2500 Pickup 98-94; K2500 Suburban 98-94; Tahoe 00-95;

RAMF-390279

LUSAC	RAYBESTOS	AUTOPAR	WAGNER	RUVILLE	OEM
LC-390279	MC390279	FCM09031	F131509	BMC10165	18029969



31.7 mm 1-1/4"

CHEVROLET C-30, C-35, C35, C3500, C3500 HD, PANEL-30

RAMF-390386

LUSAC	RAYBESTOS	AUTOPAR	WAGNER	RUVILLE	OEM
390386	MC390386	FCM09035	F131955	BMC10185	18029862



25.4mm 1"

Chevrolet Malibu LX, 97-01 y 05, Malibu LS 97-01 y 05, Grand Am ABS 99-00

RAMF-390542

LUSAC	RAYBESTOS	AUTOPAR	WAGNER	RUVILLE	OEM
LC-18060790	MC390542	FCM09055	M630035	BMC10216	18043278



37.00 mm

AVALANCHE 2500, ESCALADE, ESCALADE EXT, SILVERADO 1500 2WD Y 4WD 4 PTS, HEAVY DUTY

RAMF-390801

LUSAC	RAYBESTOS	AUTOPAR	WAGNER	RUVILLE	OEM
LC-390801	MC39571		MC252650	BMC10472	3492467



20.6mm 13/16"

CHEVY JOY, SWING, MONZA, CHEVY POP, CHEVY VAGONETA, CHEVY PICK UP

RAMF-39571

LUSAC	RAYBESTOS	AUTOPAR	WAGNER	RUVILLE	OEM
LC-39571	MC39571	FCM09004	F139952	BMC10472	18029949



24.0 & 36.0 mm

PICK UP S-10, BLAZER

RAMF-98953

LUSAC	RAYBESTOS	AUTOPAR	WAGNER	RUVILLE	OEM
98953	MC39017	FCM09005	F98953	BMC10142	14036115 6260725 14036115

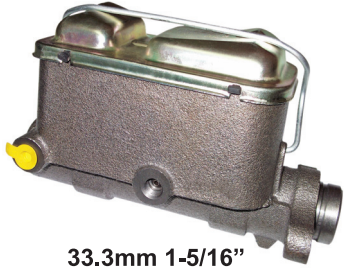

33.3mm 1-5/16"

Chevrolet C-30, C-35 76-89 Rodada Doble,
C-30, C35 82-83 Rodada Sencilla, Panel P30 82-92 y 97-98

RAMF-39913

LUSAC	RAYBESTOS	AUTOPAR	WAGNER	RUVILLE	OEM
LC-39913	CMA39313		F111151		UB9341400A



15.8mm 5/8"

MAZDA MOTOR 2.2 Y2.6L PICKUP, B2000, B2200, B2600 (MOD USA)

RAMC-033.5

LUSAC	RAYBESTOS	AUTOPAR	WAGNER	RUVILLE	OEM



Mercedes-Benz



Cilindro Maestro de Embrague Camion Mercedes Benz 366 Embrague

46010-VW001

LUSAC	RAYBESTOS	AUTOPAR	WAGNER	RUVILLE	OEM



C.M CON NISSAN URVAN 04-09

RAMF-39555

LUSAC	RAYBESTOS	AUTOPAR	WAGNER	RUVILLE	OEM
39555	MC39555		F108696	BMC10470	4601004B00 4601004B05 4601004B06 4601004B15



19.0mm / 23.8mm

Nissan Hikari 88-92, Samurai 83-84, Tsuru I 84-87,
Tsuru II 88-92, (Cilindro Tokico)

RAMF-39567

LUSAC	RAYBESTOS	AUTOPAR	WAGNER	RUVILLE	OEM
39567	MC39567		F113427	BMC10471	E6TZ2140A



23.8 - 15/16"

Ford Bronco II 86-90, Ranger 86-90

RAMF-39592

LUSAC	RAYBESTOS	AUTOPAR	WAGNER	RUVILLE	OEM
39592	MC39592				



23.8mm 15/16"

C.M Nissan Pick Up Doble Cabina 91-92

RAMF-39593

LUSAC	RAYBESTOS	AUTOPAR	WAGNER	RUVILLE	OEM
39593	MC39593	FCM20002	F115590	BMC10476	4601001G00 4601001G00



25.4mm 1"

Nissan Pick Up D-21 91-96, Pick up 250 94-96

RAMF-4601000Q

LUSAC	RAYBESTOS	AUTOPAR	WAGNER	RUVILLE	OEM
LC-4601000Q	4601000Q		M639014	BMC10120	46010-00 QAA

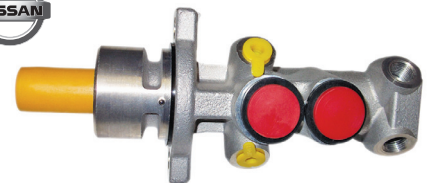

20.6mm 13/16"

NISSAN PLATINA, CLIO, CLIP EXPRESSION, CLIO ENERGY

RAMF-4601009G00

LUSAC	RAYBESTOS	AUTOPAR	WAGNER	RUVILLE	OEM
LC-39594	MC39594	FCM20010	F116426		46010-09G00



23.8mm 15/16"

NISSAN D21, NISSAN PATHFINDER (MOD USA)

RAMF-4601072Y04

LUSAC	RAYBESTOS	AUTOPAR	WAGNER	RUVILLE	OEM



Cil.Mtro Freno con sensor Tsuru III Sentra B13 Dep. Alargado

RAMF-46010A05

LUSAC	RAYBESTOS	AUTOPAR	WAGNER	RUVILLE	OEM
46010A05	MC39555		F108696	BMC10470	4601004800 4601004805 4601004806 4601004815



Nissan Tsuru I 84-87, Tsuru II 88-92, (Cilindro Tokico) Hikari 88-91, Samurai 83-84

RAMF-46010F4001

LUSAC	RAYBESTOS	AUTOPAR	WAGNER	RUVILLE	OEM
46010F40	BMC10488				46010F4001



Nissan Estaquitas Pick up 87-94, Pick up D-21 92-03, Pick up Doble Cabina 91-03, Pick up corto 90-00, Pick up King Cab 95-00, Pick up Largo 97-03, Pick up 250 94-96, Estaquitas Pick up 95-02

RAMF-46010-W87

LUSAC	RAYBESTOS	AUTOPAR	WAGNER	RUVILLE	OEM
46010W87	MC39150	FCM09022	F122617	BMC10143	18021213



Cilindro de freno maestro doble 7/8 Nissan, Nissan Datsun 79-84

RAMF-390921

LUSAC	RAYBESTOS	AUTOPAR	WAGNER	RUVILLE	OEM
390921					

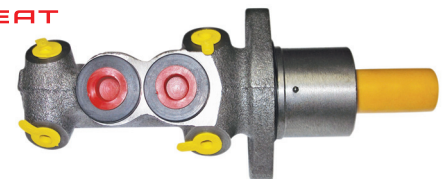

22.2mm 7/8"

Seat Cordoba 01-08, Leon 01-04

RAMF-110983

LUSAC	RAYBESTOS	AUTOPAR	WAGNER	RUVILLE	OEM
LC-110983	MC39655	FCM28004	F110983	BMC10484	191611019

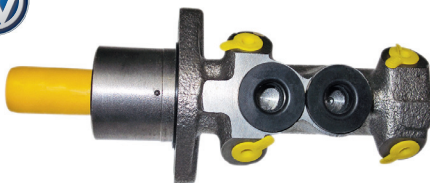

20.6mm 13/16"

VW GOLF A-2 C, CI, GI, GOLF GTI A2 89-90, JETTA A2, JETTA A3 CI, GI

RAMF-113611021C

LUSAC	RAYBESTOS	AUTOPAR	WAGNER	RUVILLE	OEM
					113611021C



Cil.Mtro Freno V.W. Sedan 66-91 = 90547

RAMF-1J1614019

LUSAC	RAYBESTOS	AUTOPAR	WAGNER	RUVILLE	OEM
390500	MC390500		F140063	BMC10202	1J1614019



23.8mm 15/16"

Volkswagen Beetle 2.0 Its 98-05, Beetle Turbo 1.8 Its 00-05, Beetle Cabriolet Turbo 1.8 Its 03-05, Golf GTI A4 2.0 Its S/ABS 00-05, Golf A4 2.0 Its S/ABS 00-06, Jeta 2.0 Lts A4 00-05

RAMF-390060

LUSAC	RAYBESTOS	AUTOPAR	WAGNER	RUVILLE	OEM
LC-390060	MC390060	FCM28011	F128225	BMC10134	1H1611019C

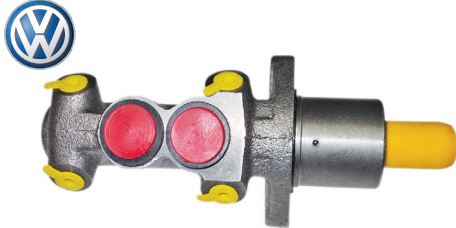

20.6mm 13/16"

V.W. GOLF A3 CL, GL, GOLF A3 GLS, GOLF CABRIO A3, GOLF GTI A3, JETTA A2, GOLF GTI A2, JETTA A2 GLI, JETTA GLS A3

RAMF-390271

LUSAC	RAYBESTOS	AUTOPAR	WAGNER	RUVILLE	OEM
LC-390271	MC390271	FCM28005	F140064		357611019B



22.2mm 7/8"

VW GOLF A3 CL, GL, 1.8 LTS, GOLF A3 GLS 2.0 LTS, GOLF A3 GTI VR6, GOLF CABRIO A4 2.0LTS, GOLF GTI A3, JETTA A3 CL, GL, 1.8 LTS, JETTA GLS A3 2.0 LTS, JETTA A3 VR6, PASSAT VR6 2.8 LTS, HONDA CR-V EXL

RAMF-390901

LUSAC	RAYBESTOS	AUTOPAR	WAGNER	RUVILLE	OEM
390901		FCM28013			377611015A

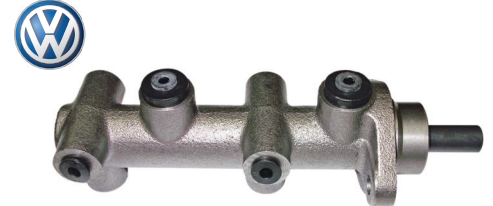

20.6mm 13/16"

VolkswagenPointer 1.8 Lts 98-02 Pointer City 00-02 Pointer Vagoneta 99-02

RAMF-96409

LUSAC	RAYBESTOS	AUTOPAR	WAGNER	RUVILLE	OEM
LC-96409	MC39147	FCM28003	F96409		171611019A



20.6mm 13/16"

VW. ATLANTIC, CARIBE, CERIBE GT, CORSAR

RAMF-96415

LUSAC	RAYBESTOS	AUTOPAR	WAGNER	RUVILLE	OEM
LC-96415	MC36275	FCM28002	F96400	BMC10129	1136110-15BD

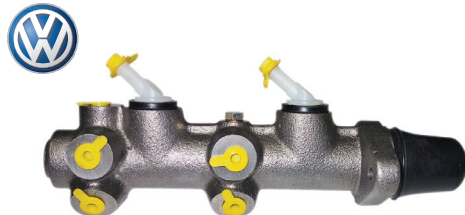

19.0mm 3/4"

VW. SEDAN

1. Por los puertos de salida rellene con una jeringa sin aguja, el cilindro maestro con líquido para frenos LF 3 (DOT3) o LF4 (DOT4) de acuerdo a especificación que se indica en la tapa del depósito.

2. Sujete el cilindro maestro por la placa de montaje en un tornillo de banco.

No exceda el apriete ya que podría dañar el producto (FIG.1).

3. Inserte los conos a las mangueras. (componentes del kit de purga).

4. Fije el sujetador que viene dentro del kit de purga, en el cuerpo del depósito del cilindro maestro.

5. Llene a la mitad con líquido para frenos el depósito del cilindro maestro y sumerja las mangueras asegurándose que no queden fuera del líquido, asegúrelas en mediante el sujetador.

6. Inserte los conos de cada adaptador del kit de purga en cada uno de los puertos de admisión, asegurándose de que queden bien sujetos (FIG.2).

7. Bombee lentamente asegurándose de que el recorrido no sea mayor a $\frac{3}{4}$ de pulgada suficiente para que los pistones rebasen los puertos de admisión del cilindro, suelte la varilla y permita que el pistón regrese a su posición de reposo topando con el seguro, espere 5 segundos y repita la operación de bombeado hasta que las burbujas de aire dejen de salir por las mangueras.

No saldrá todo el aire del cilindro si alguna de las mangueras se encuentra fuera del líquido para frenos. (Utilice una varilla con un extremo redondeado para la operación de bombeo).

8. Instale el cilindro en el vehículo, retire los conos adaptadores y conecte las tuberías del vehículo y rellene a nivel el depósito para líquido de frenos.

9. Purgue las líneas de las cuatro ruedas por los tornillos purgadores consulte el manual del fabricante para utilizar el procedimiento de purga adecuado (FIG.3).

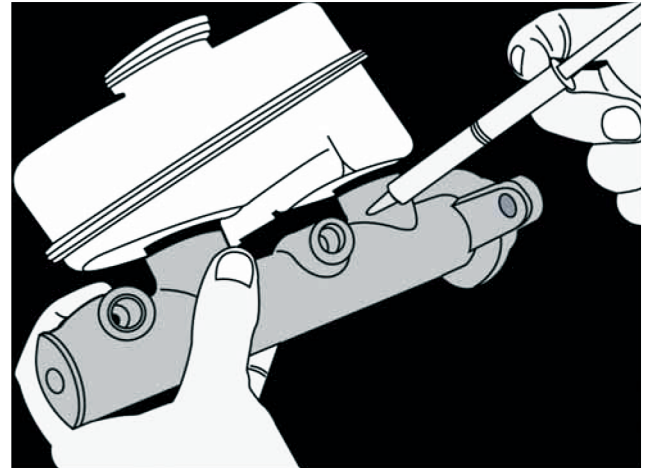

(FIG.1)

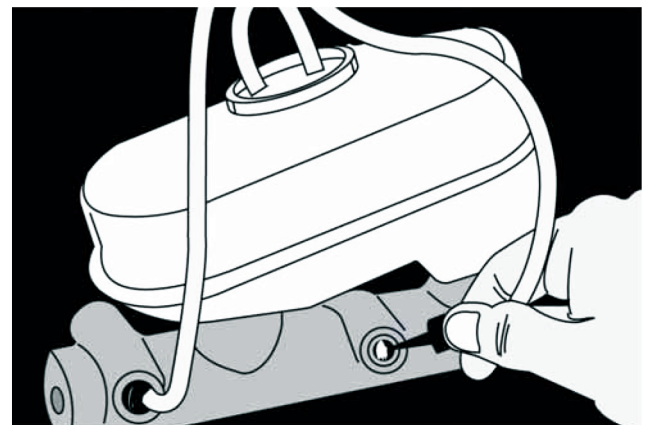

(FIG.2)

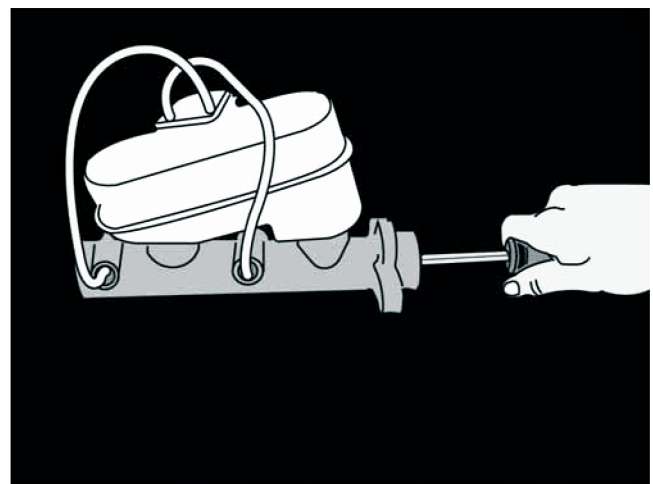

(FIG.3)

POSIBLE CAUSA / VERIFIQUE:

¿Porqué el vehículo tiene un pedal bajo o esponjoso?

- *Aire dentro del sistema hidráulico
- *Ajuste de la zapata trasera
- *Ajuste de la varilla de empuje
- *Cilindro maestro purgado inadecuadamente

¿Porqué el vehículo no se detiene después del cambio de balatas?

- *Acabado inadecuado del rotor
- *Material de fricción incorrecto
- *Área de fricción dañada durante el periodo de asentamiento

¿Porqué rechina durante la frenada?

- *Material de fricción instalado inadecuadamente
- *Herraje del cáliper dañado
- *Falta de lubricación
- *Liga de cáliper pegada

¿Porqué el sonido de metal-metal durante el frenado?

- *Acabado inadecuado del rotor
- *Falta de limpieza al Rotor después de haber sido rectificado
- *Balatas desgastadas excesivamente

¿Porqué una o más de las ruedas traseras se amarran durante el frenado?

- *Muelles o resortes de freno debilitados
- *Tambores de freno ovalados o de diámetro excesivo
- *Platos de apoyo dañados
- *Cilindros de rueda sueltos
- *Forro contaminado

¿Cuáles son las especificaciones apropiadas para rectificar tambores y discos?

- *Refiérase al manual de servicio adecuado. La práctica general es que los discos deben rectificarse a no menos de .030" por encima del mínimo espesor especificado en el disco (esto no aplica a todos los discos)
- *Los tambores en un mismo eje no deben tener una diferencia mayor a .010" en el diámetro uno con respecto al otro, y al menos .015" por encima de las especificaciones mínimas, esto sólo si no hay ninguna especificación disponible en un manual de servicio

¿Porqué la pulsación fuerte del pedal durante el frenado?

- *Ruedas instaladas con llave neumática lo cual puede causar que se deformen los discos
- *Reborde de oxidación en la superficie de la maza o la brida del eje
- *Deformación causada por el calor excesivo de frenos que se patinan
- *Rotores excesivamente rectificadas
- *Exceso de temperatura en los discos

¿Son los líquidos de freno DOT3, 4 y 5 compatibles y cual es la diferencia?

- *Los líquidos de freno DOT 3 y 4 son compatibles uno con el otro, pero no se deben mezclar
- *Los fluidos para frenos DOT 3 y 4 tienen glicol como base, y absorbe la humedad (higroscópico)
- *DOT 5 tiene silicón como base, y no absorbe la humedad

¿Qué procedimiento se utiliza para diagnosticar la válvula de medición, dosificación y/o de combinación?

- *Los manómetros de presión para frenos deben utilizarse en conjunto con un manual de servicio apropiado

¿Porqué el vehículo se jala a un lado al frenarlo?

- *Componentes de la dirección dañados o flojos (barra de acoplamiento de la dirección, articulación de rótula, etc)
- *Manguera de freno dañada
- *Cáliper dañado

¿Porqué el pedal todavía está bajo y esponjoso después de que se ha cambiado el cilindro maestro?

- *Aísle los componentes del freno (utilice el método de pinzas de bloqueo) para localizar aire atrapado en el sistema
- *Verifique buscando movimiento mecánico excesivo en el cáliper o el cilindro de rueda

¿Porqué el pedal está alto y duro cuando el pedal del freno se aplica?

- *Baja alimentación de vacío hacia el Booster
- *Booster dañado
- *Restricción en la línea de alimentación de vacío
- *Válvula de retención del Booster dañada
- *Cálipers o cilindros de rueda pegados

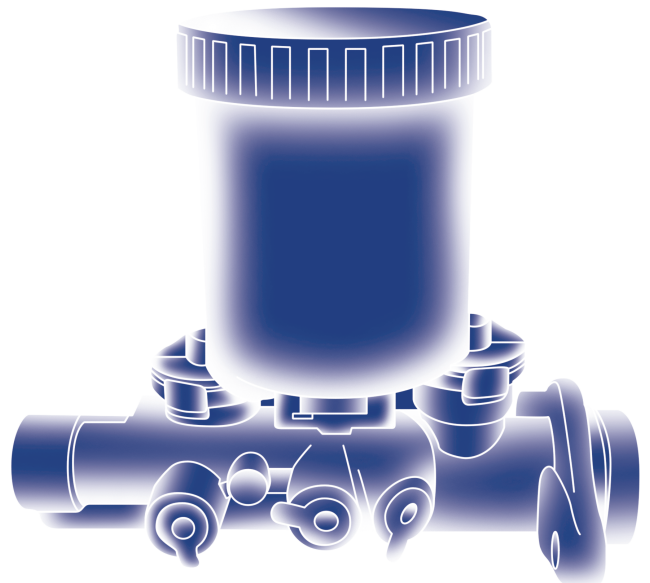
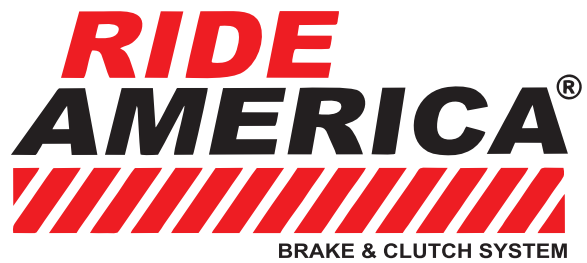

ventas@herko.com.mx

DISTRIBUIDOR
AUTORIZADO



HERKO AUTOMOTIVE
Oficinas en México
Margarita Maza de Juarez #191,
Nueva Industrial Vallejo, México, D.F. C.P. 07700,
Del. Gustavo A. Madero,
Telefono: 01 (55) 5999 1590 Fax. 01 (55) 5999 1590 ext. 107
Servicio Técnico: 01 (55) 5586 1088 www.herko.com.mx